



Image of 120x60cm model Ref.:BAL120SCL (on the left) and the Ref.:LIGC090L model applied (ambient image).

DESCRIPTION

JOCAVI® supplies high-tech efficient and delicate luminaires and downlights mounted on some of our benchmark absorbent panels.

These two types of LED lamps; luminaires and downlights offer respectively a perfectly uniform or directionality light beam making these a perfect solution for more demanding lighting spaces.

These acoustic panels incorporate highly efficient LED Array, comprised a rail of direct light, suspended by four invisible nylon cables, serving as anchors and electrical wiring. Available on the following models; MELLOWALLTRAP®, LIGHTWALLTRAP®, BASMEL® and COOKIE®.

Perfect for all spaces requiring acoustic absorption along with and at the same time lighting options; for offices, studios or places where the efficiency and comfort are needed.

MODELS AND SIZES

MODELS	HEIGHT	WIDTH	DEPTH	WEIGHT
MEL180L/ LB	180 cm (70.9 in)	60 cm (23.6 in)	8 cm (3.1 in)	14.2 Kg (31.31 lbs)
MEL120L/ LB	120 cm (47.2 in)	60 cm (23.6 in)	8 cm (3.1 in)	9.5 Kg (20.94 lbs)
LIG180L/ LB	180 cm (70.9 in)	90 cm (35.4 in)	7 cm (2.8 in)	22.5 Kg (49.60 lbs)
LIG090L/ LB	90 cm (35.4 in)	90 cm (35.4 in)	7 cm (2.8 in)	12.7 Kg (28.00 lbs)
LIGR120L/ LB	-	∅ 120 cm (47.2 in)	7 cm (2.8 in)	12.4 Kg (27.34 lbs)
LIGR090L/ LB	-	∅ 90 cm (35.4 in)	7 cm (2.8 in)	9.3 Kg (20.50 lbs)
LIGC090L/ LB	90 cm (35.4 in)	90 cm (35.4 in)	7 cm (2.8 in)	10.1 Kg (22.27 lbs)
BAL180SCL	180 cm (70.9 in)	60 cm (23.6 in)	8 cm (3.1 in)	3.13 Kg (6.90 lbs)
BAL120SCL	120 cm (47.2 in)	60 cm (23.6 in)	8 cm (3.1 in)	2.12 Kg (4.67 lbs)
COK120SCL	-	∅ 120 cm (47.2 in)	6 cm (2.4 in)	1.10 Kg (0.46 lbs)

FEATURES (with Linne S O model)

- Velvety finishing and acoustic foam with fabric;
- Fire-resistance: Euroclass B (similar to old M1);
- HO (High Output Stream); Photometric Code 830-840;
- Luminous Flux 2231/ 2422 (lm); System Efficiency 110/120 (lm/W);
- Temperature Colour: 4000 (K); LED high lifetime (>50 000h);
- Installation: accessories included;
- Other sizes available on demand.

FEATURES (with Elementare model)

- Velvety finishing and acoustic foam with fabric;
- Fire-resistance: Euroclass B (similar to old M1);
- HO (High Output Stream); Photometric Code 827-940;
- Luminous Flux 4032/ 3752 (lm); System Efficiency 100-93 (lm/W);
- Temperature Colour: 5000 - 4000 (K); LED high lifetime (>50 000h);
- Installation: accessories included;
- Other sizes available on demand.

TECHNICAL DRAWINGS (with Linne S O model)

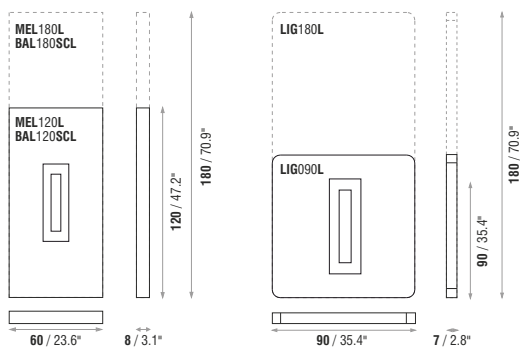

TECHNICAL DRAWINGS (with Elementare model)

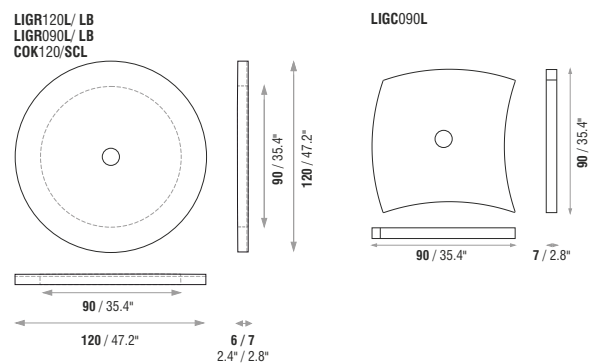

STANDARD FABRIC COLOURS

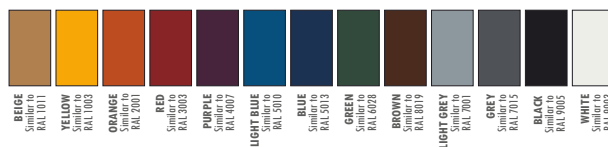

VELVETY COLOURS



IMPORTANT NOTICES

- JOCAVI® accepts no responsibility for any printing errors. Specifications can be modified without prior notice, if technical or commercial reasons so require.
- The colours shown in this catalogue are only a reference and an illustration of the products finishing. The colours shown are not binding because brightness, contrast and colour balance may vary due to the printing process.
- Colours may vary due to raw-material suppliers' changes and some differences may occur in tonal range.
- Typical Indoor Comfort Standards state a temperature range of 20°C - 27°C (68°F - 81°F), and a relative humidity of less than 60%. These would be considered as normal operational levels of JOCAVI® products' range.
- Despite all the standard sizes of all products, this model can be customised upon previous consultation. Sizes may vary slightly (+/-3mm) due to their production method and some inherent raw-materials characteristics.

MELLOWALLTRAP®

ABSORPTION COEFFICIENT

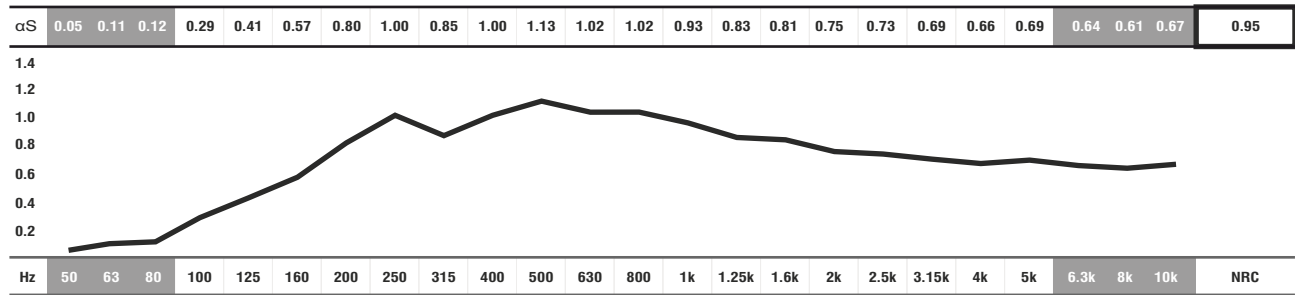

■ ABSORPTION COEFFICIENT: Values in accordance with the standards: EN 20654, ASTM C423 and EN 11654. ■ Values [$<100\text{Hz}$ and $>5\text{K}$] are Non Standard Values.

LIGHTWALLTRAP®

ABSORPTION COEFFICIENT

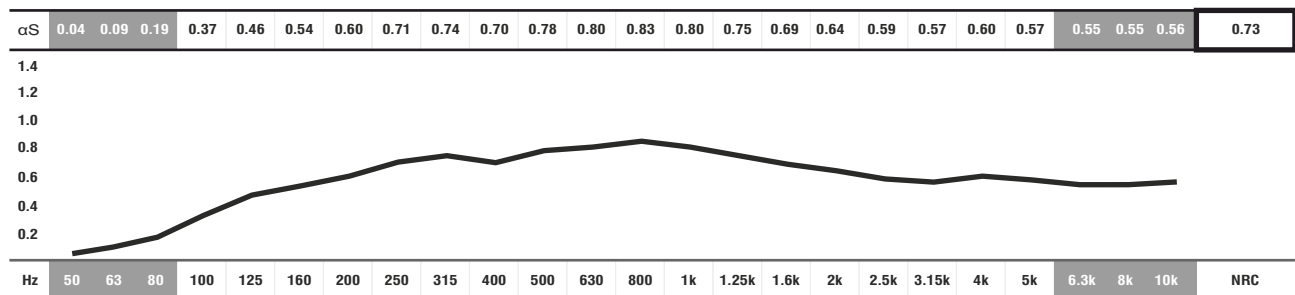

■ ABSORPTION COEFFICIENT: Values in accordance with the standards: EN 20654, ASTM C423 and EN 11654. ■ Values [$<100\text{Hz}$ and $>5\text{K}$] are Non Standard Values.

COOKIE®

ABSORPTION COEFFICIENT*

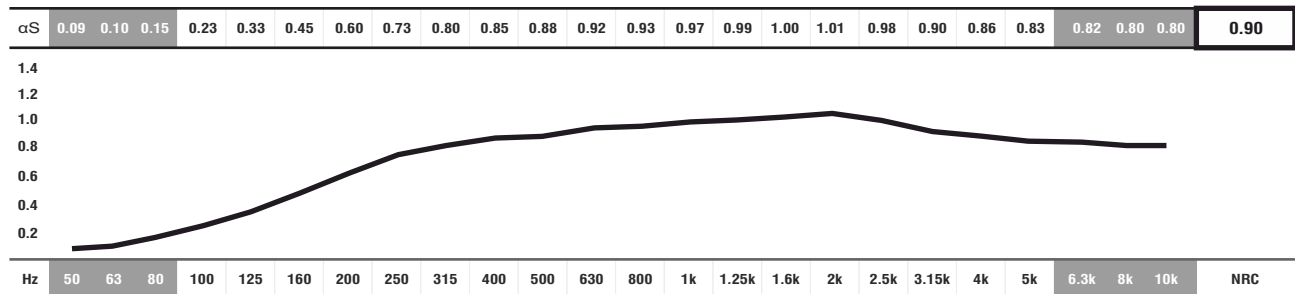

■ ABSORPTION COEFFICIENT: Values in accordance with the standards: EN 20654, ASTM C423 and EN 11654. ■ Values [$<100\text{Hz}$ and $>5\text{K}$] are Non Standard Values. *PANEL DATA ONLY OF REF: COK060 VELVETY FINISHING.

BASMEL®

ABSORPTION COEFFICIENT

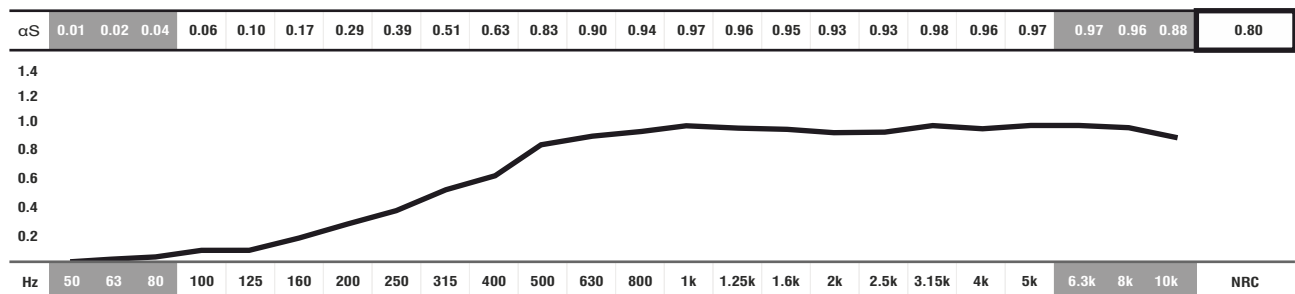

■ ABSORPTION COEFFICIENT: Values in accordance with the standards: EN 20654, ASTM C423 and EN 11654. ■ Values [$<100\text{Hz}$ and $>5\text{K}$] are Non Standard Values.